

Relief Plus XL

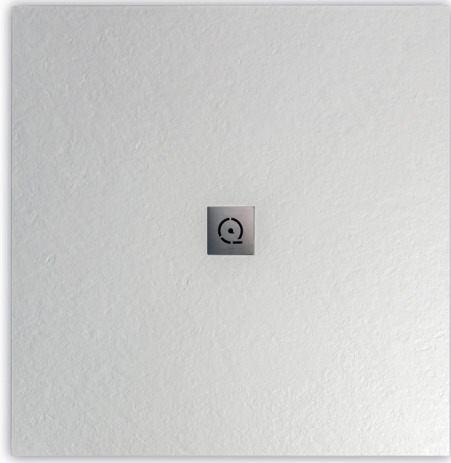

45 kg/m²

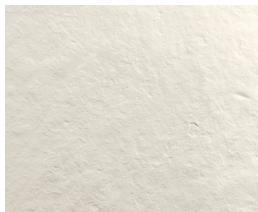
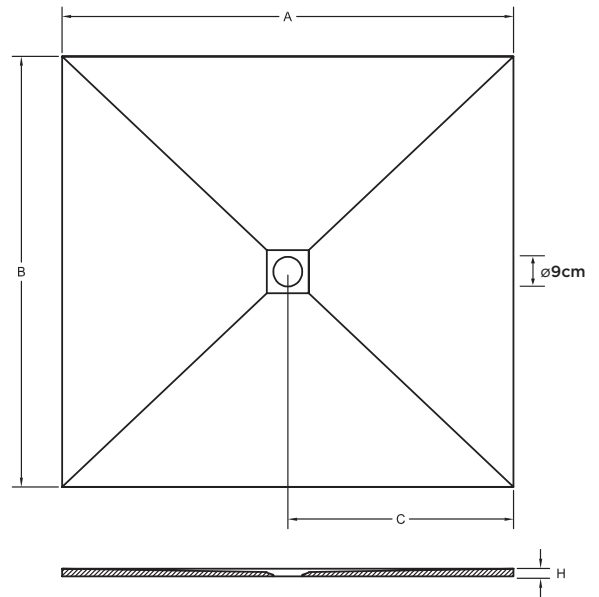

PIZARRA
A 1001-1800 | B 1001-1300
Antideslizante Clase C

		A (mm)							
		1100	1200	1300	1400	1500	1600	1700	1800
1100	C	550	600	650	700	750	800	850	900
	H	25	25	25	25	25	25	25	25
1200	C	550	600	650	700	750	800	850	900
	H	25	25	25	25	25	25	25	25
1300	C	550	600	650	700	750	800	850	900
	H	25	25	25	25	25	25	25	25

Las características técnicas podrán ser modificadas sin preaviso. Tolerancias dimensionales +/-5mm.

Colores estándar



Colores especiales



213 Colores RAL



Rejilla



Borde Rim Opcional



Válvulas

VÁLVULA EXTRA PLANA DE SERIE



VÁLVULA ORIENTABLE OPCIONAL



Garantía 5 años.



Material Quarex.
Resina + cargas minerales.



Corte a medida.
Se puede cortar en obra.



Instalación: encastado (adaptado para PRM) o sobreelevada.
Consultar manual de instalación.



Producto en Solid White.
Blanco Natural.



Revestimiento Alta resistencia a los UV.



Revestimiento DUREZA SUPERIOR (<0,01 mm, según UNE EN 14688; máximo permitido 0,1 mm)



Revestimiento de excelente resistencia a la hidrólisis.



Embalaje de cartón reforzado con estructura de madera y esquinas protectoras.



Tratamiento antibacteriano R<2 ISO 22196.